

Nominal data

Type	622 M	
Nominal voltage	VDC	12
Nominal voltage range	VDC	8 .. 15
Speed	min ⁻¹	4550
Power input	W	1.0
Min. ambient temperature	°C	-20
Max. ambient temperature	°C	75
Air flow	m ³ /h	30
Sound power level	B	4.3
Sound pressure level	dB(A)	29

ml = Max. load · me = Max. efficiency · fa = Running at free air · cs = Customer specs · cu = Customer unit
Subject to alterations

Technical features

Mass	0.085 kg
Dimensions	60 x 60 x 25 mm
Material of impeller	Fiberglass-reinforced PA plastic
Housing material	Fiberglass-reinforced PBT plastic
Direction of air flow	Air exhaust over bars
Direction of rotation	Right, looking at rotor
Bearing	Ball bearings
Lifetime L10 at 40 °C	77500 h
Lifetime L10 at maximum temperature	30000 h
Connection line	Single strands AWG 22, TR 64, bared and tin-plated.
Motor protection	Protected against reverse polarity and locking.
Locked-rotor protection	With electronic blocking and overload protection
Approval	VDE, CSA, UL, CE
Option	Special options: Speed signal Go / No-go alarm Alarm with limit speed External temperature sensor Internal temperature sensor PWM control input Analogue control input Moisture protection

622 M

DC axial compact fan

Product drawing

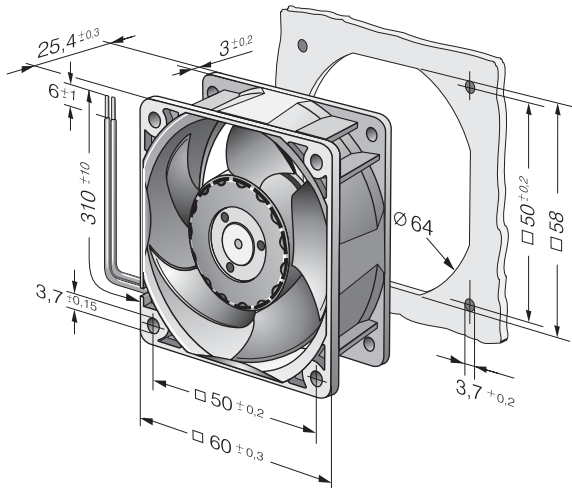

Charts: Air flow

